

10 Minute Pillow Covers

Assembly instructions and patterns for fonts and owl.

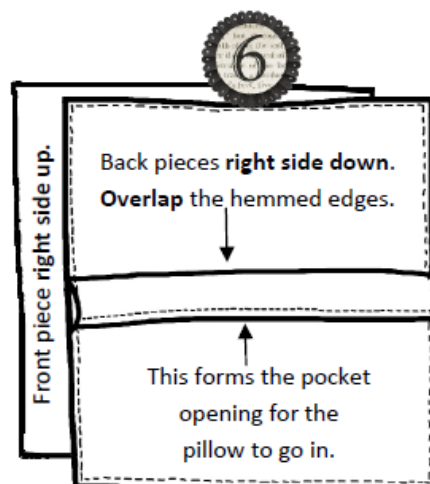

Measure your pillow

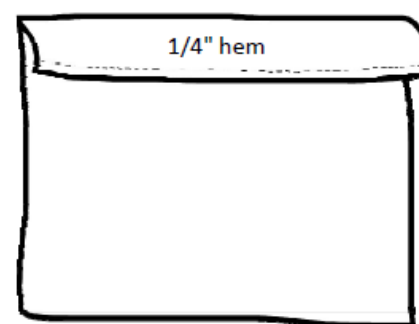
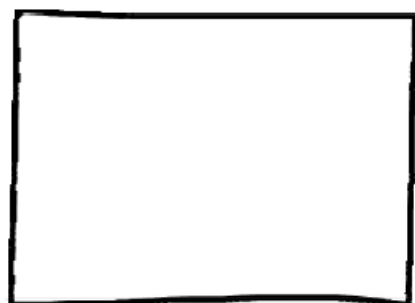
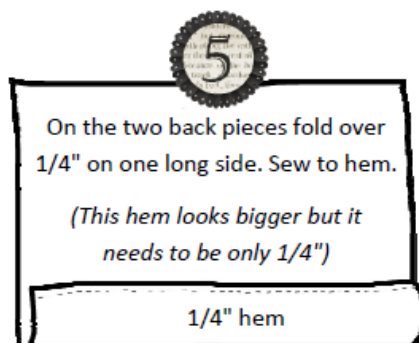
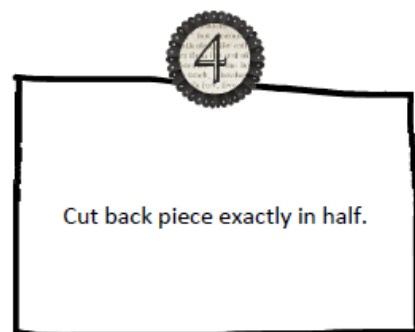
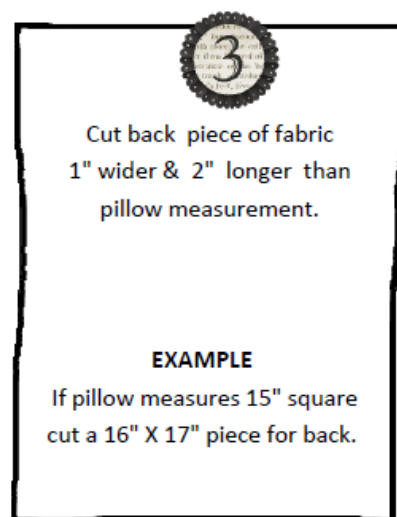
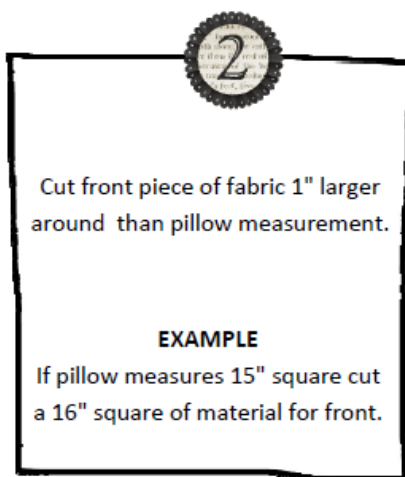

Lay front piece right side up & place each back piece face down making sure the center hemmed portions overlap in the middle. Pin & sew 1/4" around outside edges. *If you prefer less pointy corners curve them a bit as you sew.*



7

Turn your sewn case right side out and stuff the pillow into the open area!



10 Minute Pillow Covers : Owl Pattern

Cut pieces out of felt and layer as shown on photo. This owl is approximately 7" high.
Trim in spots as needed for a good fit.

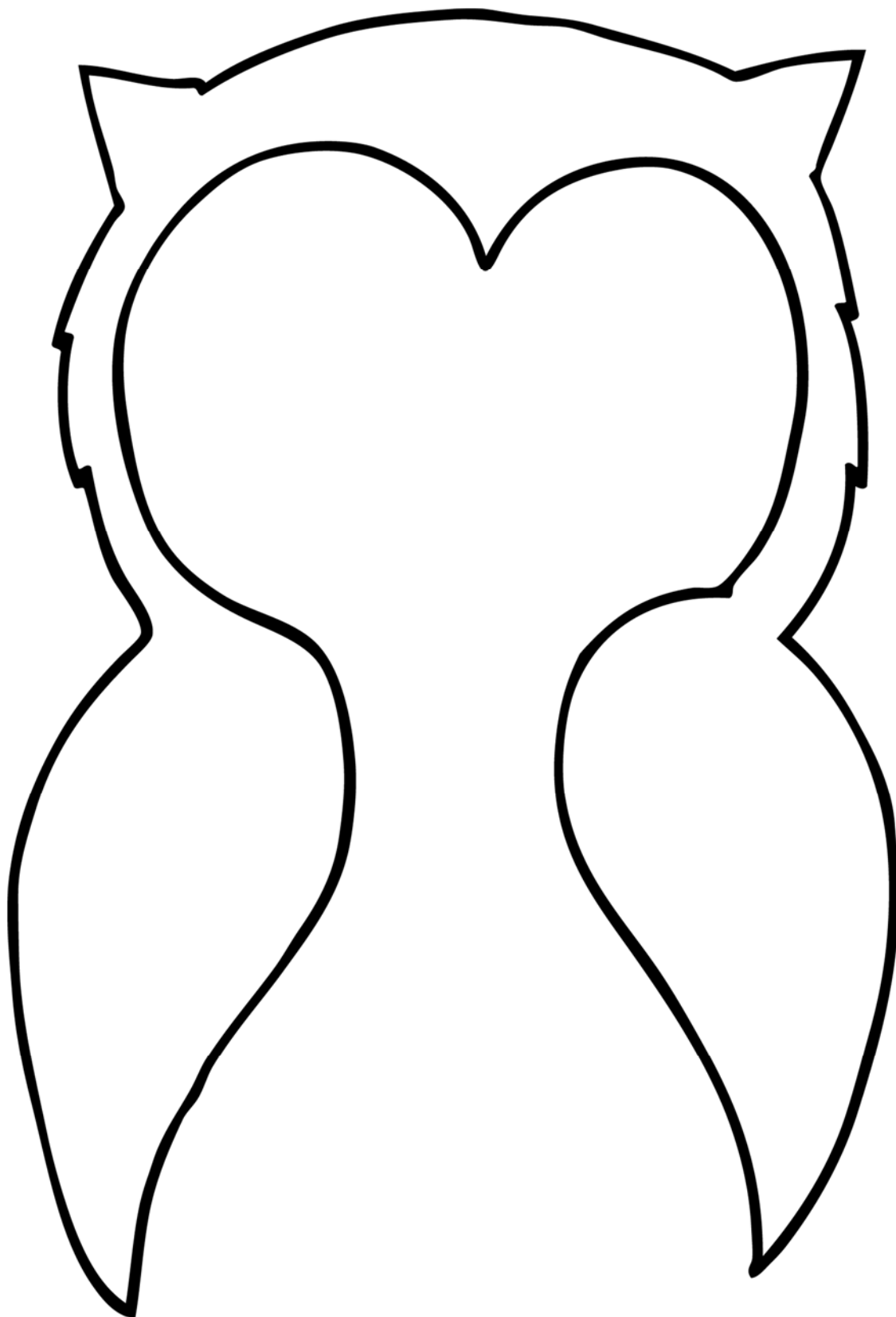

10 Minute Pillow Covers Owl

Cut pieces out of felt and layer as shown on photo. This owl is approximately 7" high. Trim in spots as needed for a good fit.

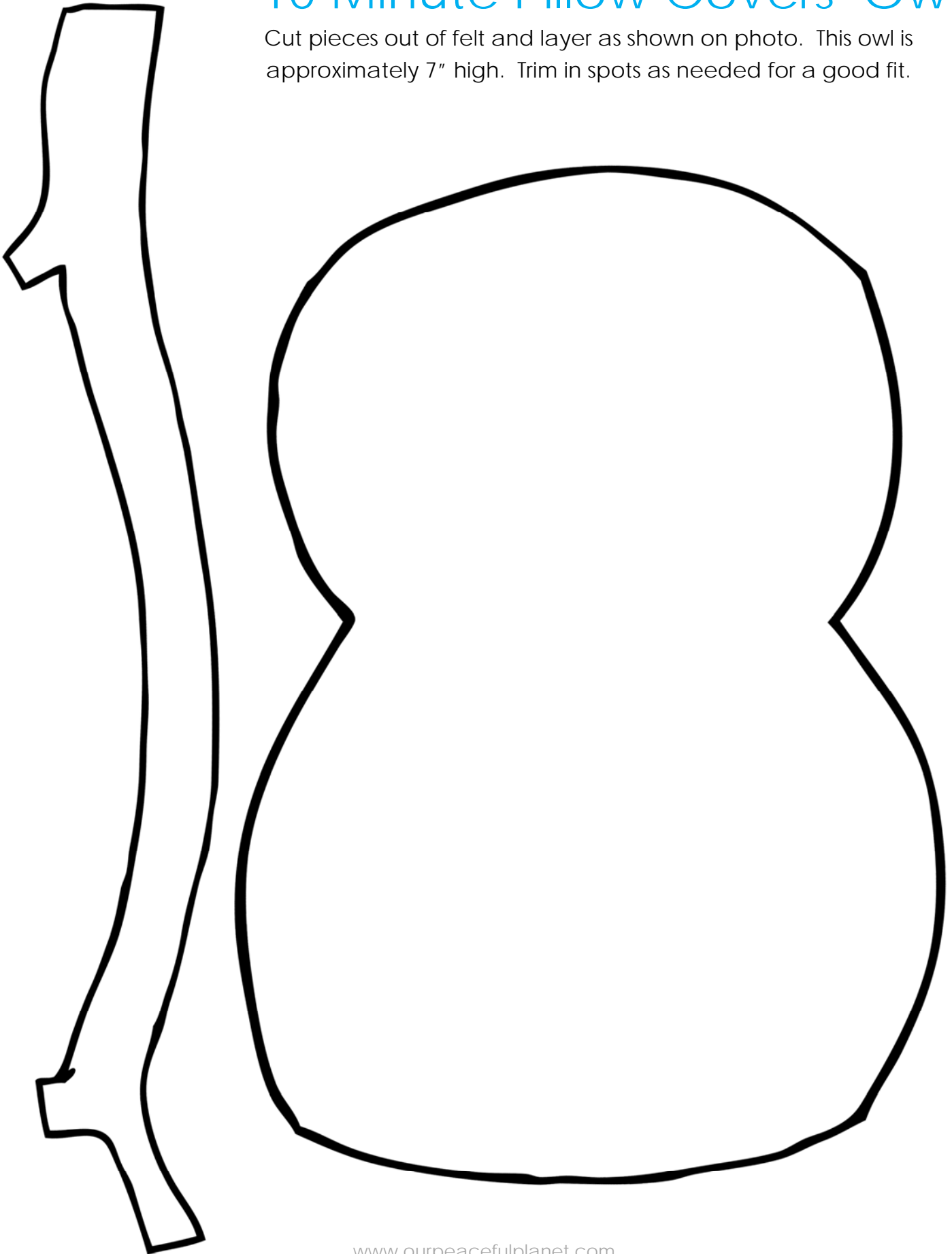

10 Minute Pillow Covers : Owl Pattern

Cut pieces out of felt and layer as shown on photo. This owl is approximately 7" high.
Trim in spots as needed for a good fit.

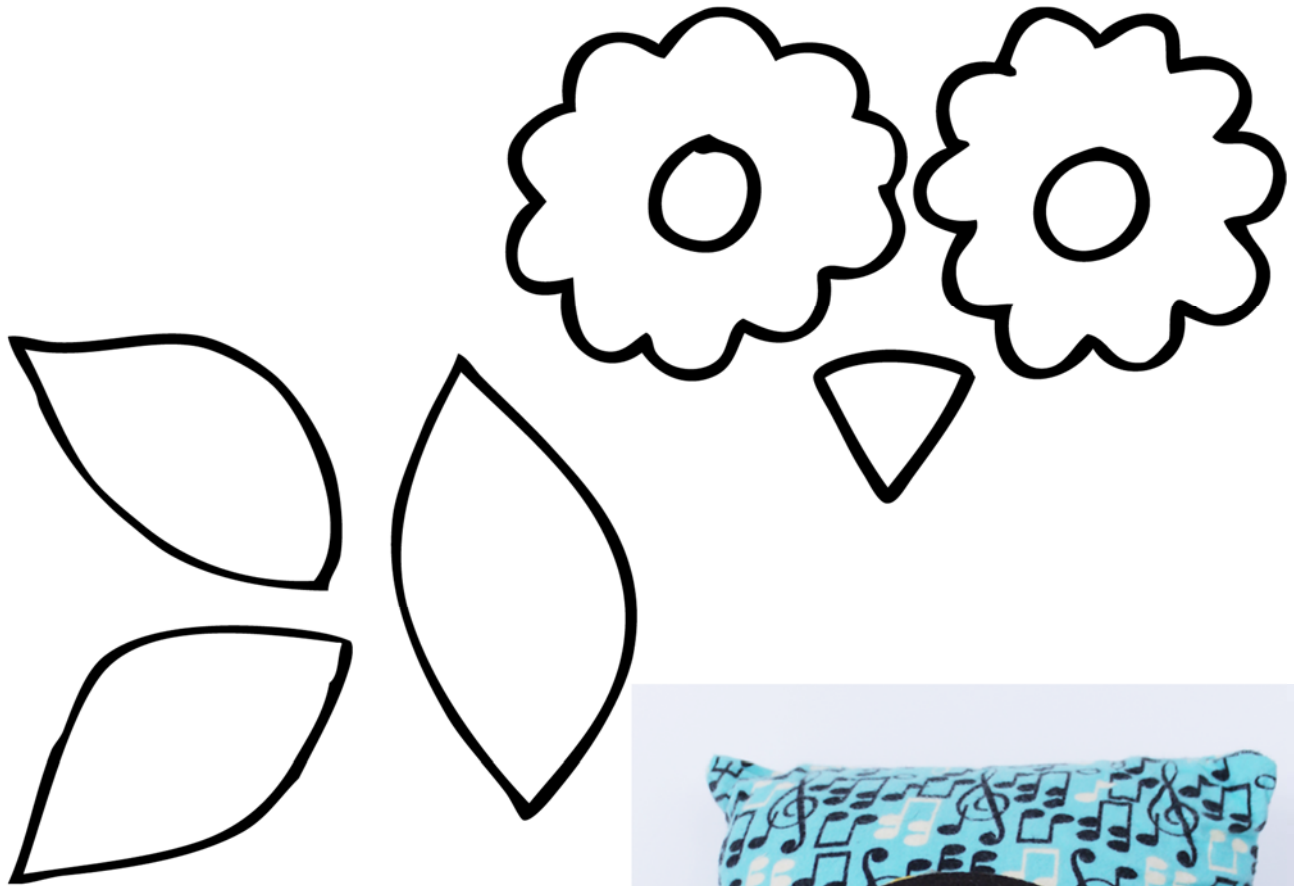

10 Minute Pillow Covers

Guitar with Strings

Cut out outside shape from felt. Cut out inner circle and string holder piece from separate color. Layer on. Use beads for pegs and sew string in as shown in photo.

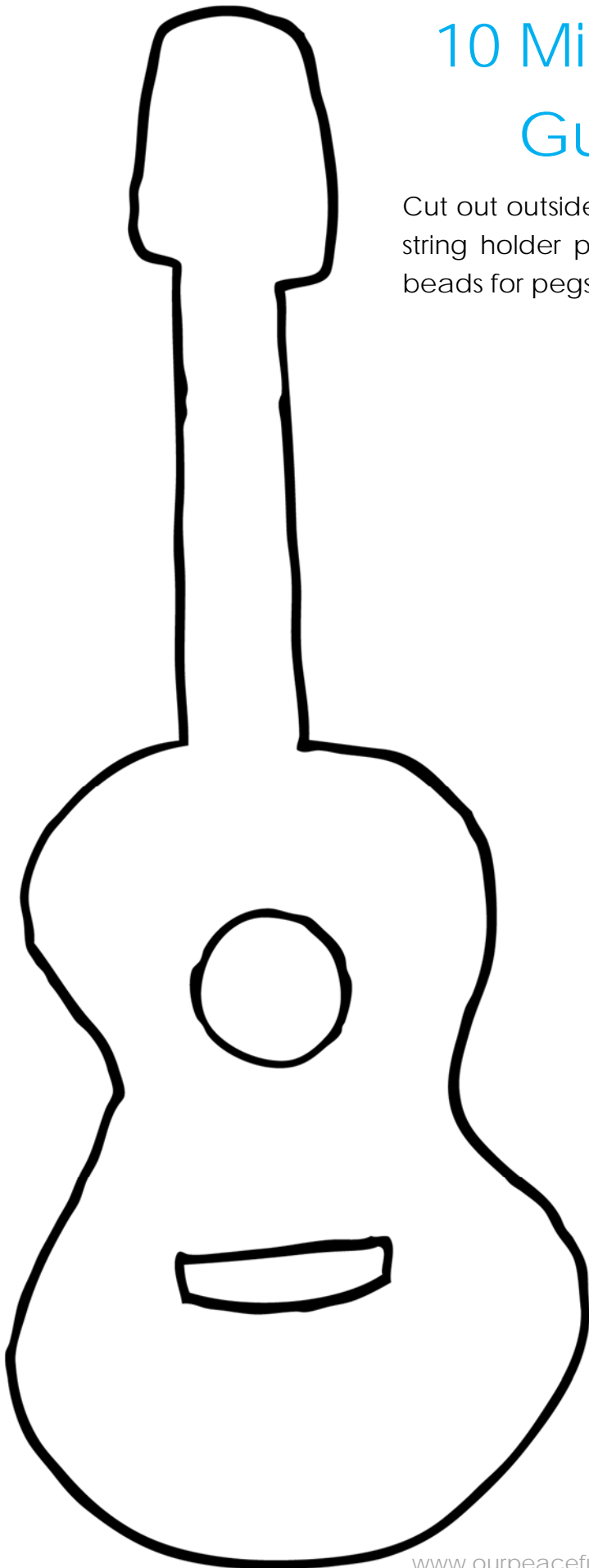

A B C

D E F

F G I J

K L M

N O P

Q R S

T U V

W X

Y Z !

